

Casetta atrezzi 180×135 cm

Attenzione! Per evitare le crepture del legno prima di iniziare il montaggio si consiglia di trapanare i fori per le viti.

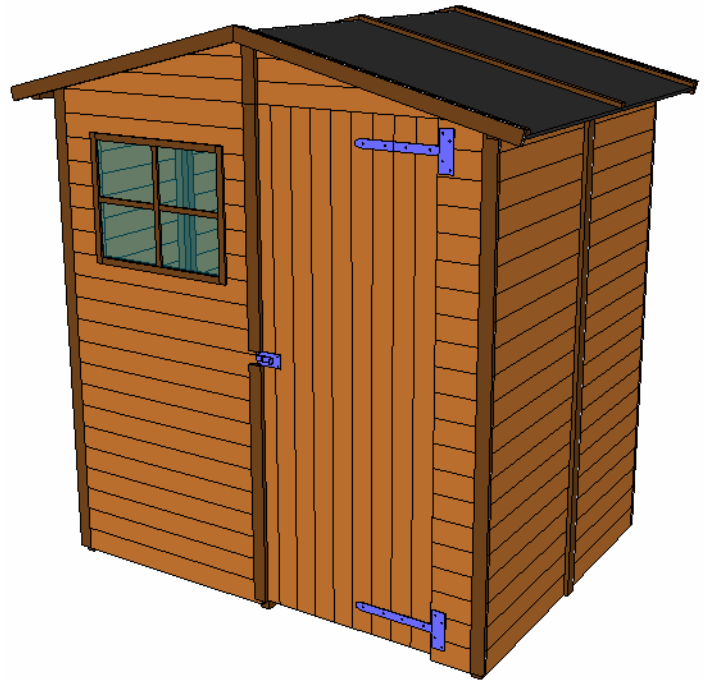

| Lettera | Viti | Quantità - pezzi |
|----------|--------------|------------------|
| a | 4×80 | 4 |
| b | 4×55 | 51 |
| c | 4×45 | 10 |
| d | 4×35 | 92 |
| e | 4×25 | 26 |
| f | 4×16 | 2 |
| - | Chiavistello | 1 |
| - | Guaina | 2 |

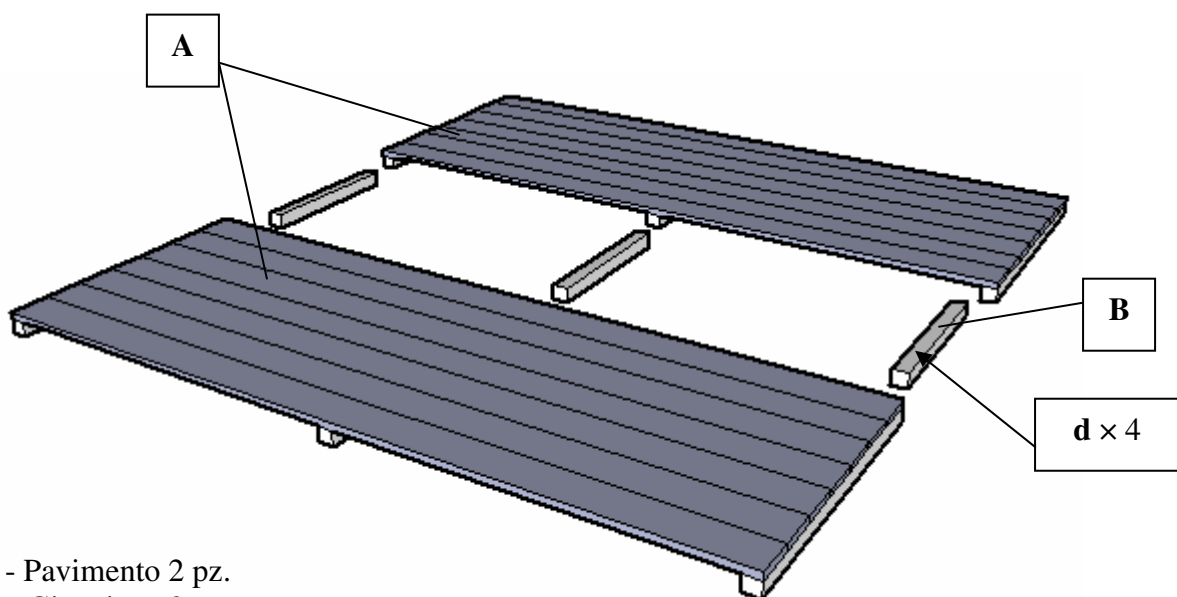

A - Pavimento 2 pz.
B - Giunzione 3 pz.

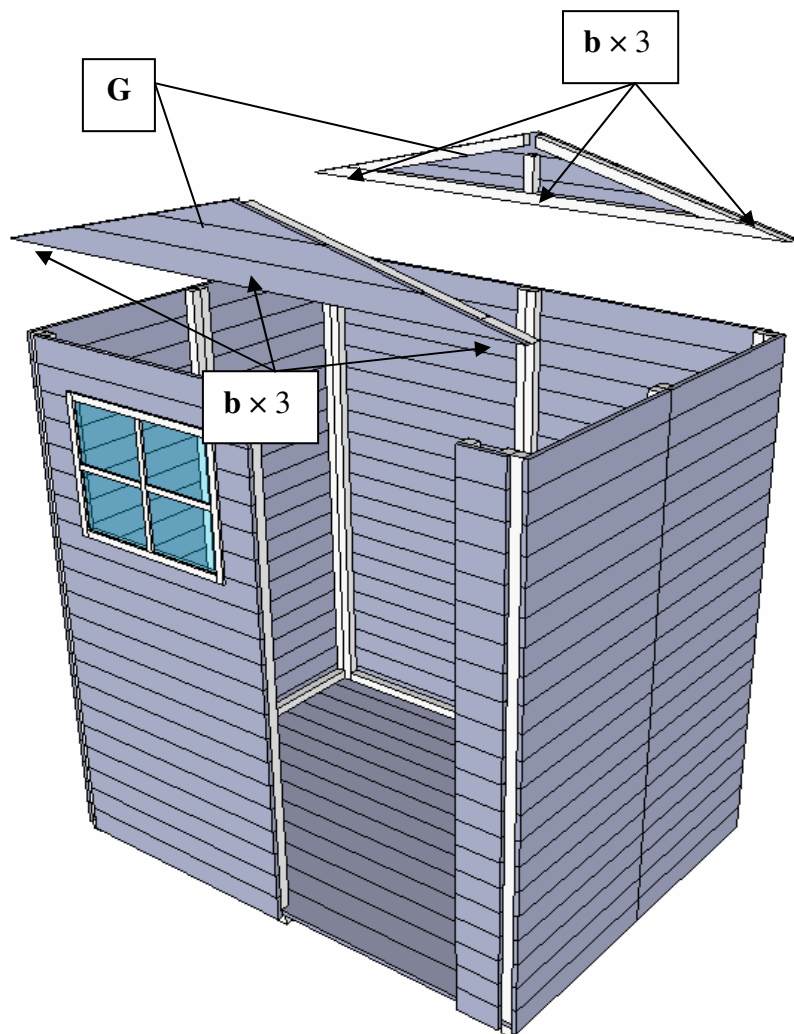
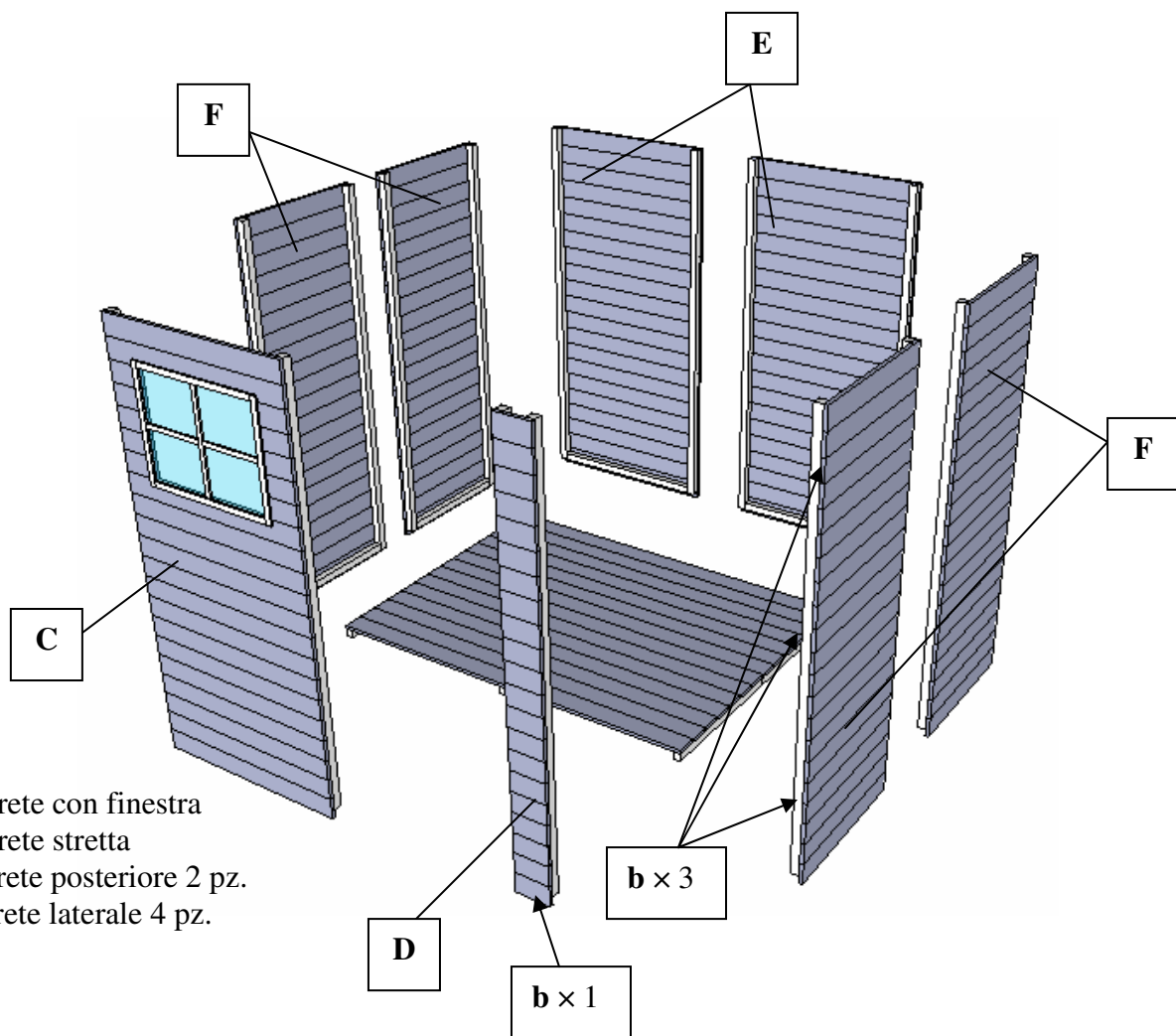

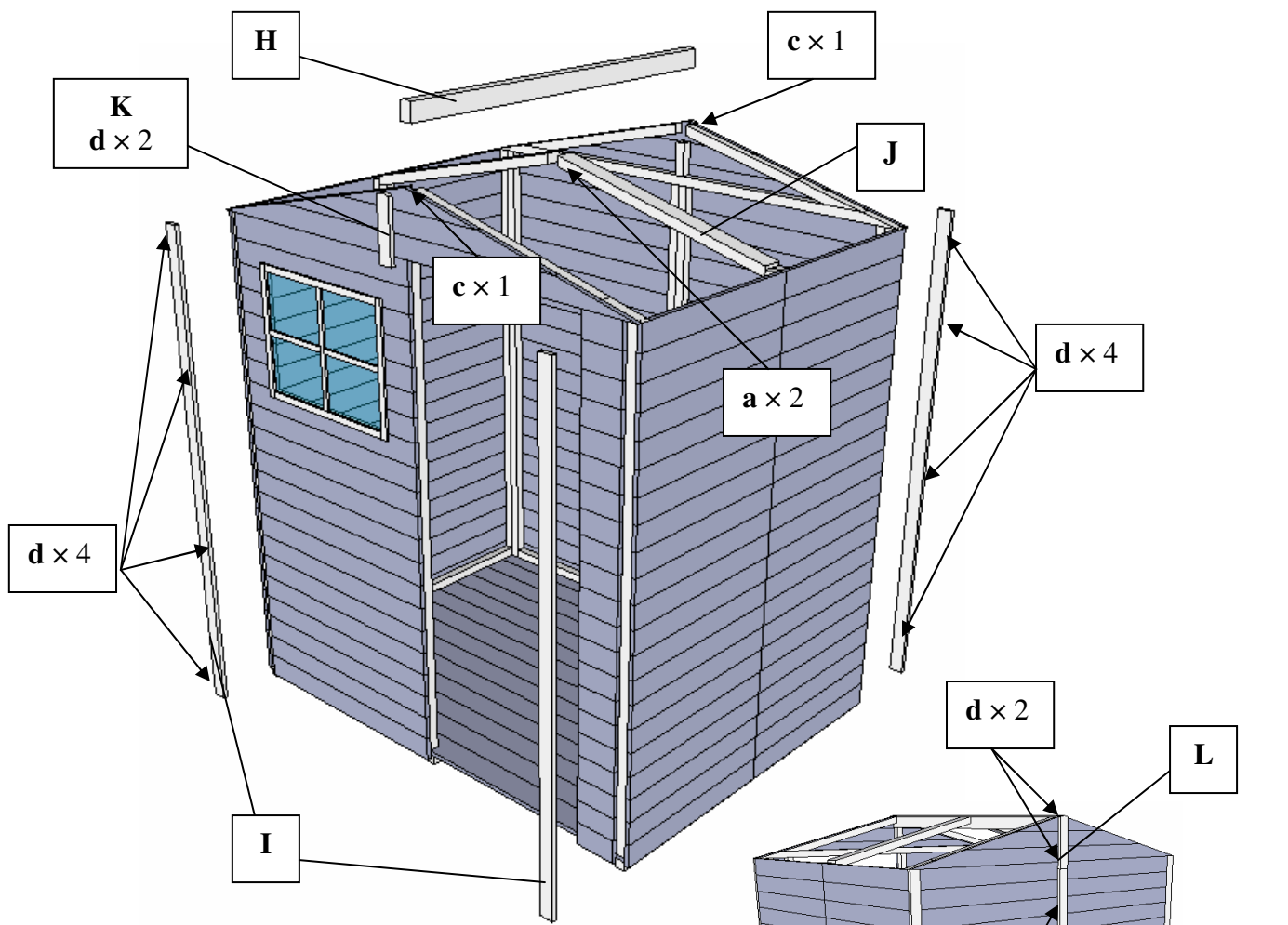

- H** – Listello di colmo
- I** – Listello copri angolo 4 pz.
- J** – Travetto tetto 2 pz.
- K** – Listello
- L** – Listello posteriore corto
- M** – Listello posteriore lungo

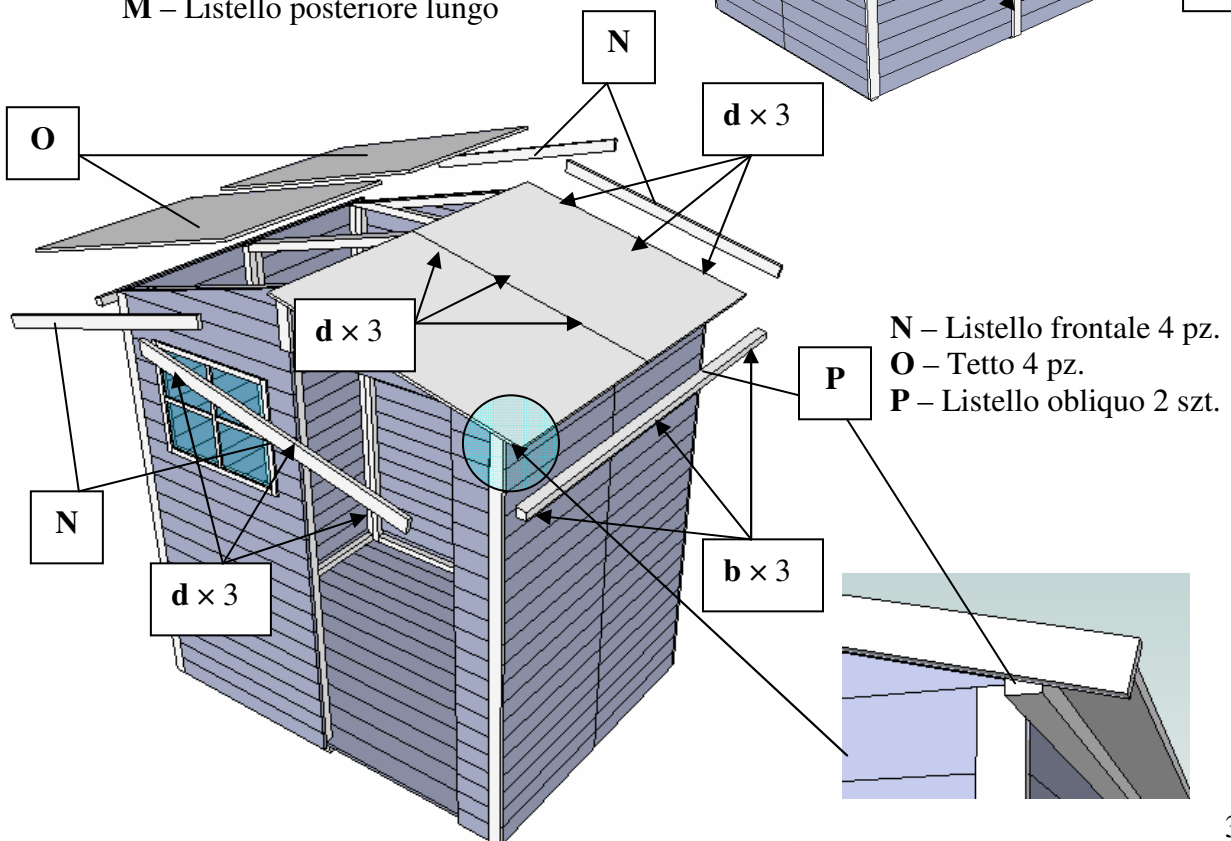

- N** – Listello frontale 4 pz.
- O** – Tetto 4 pz.
- P** – Listello obliquo 2 szt.

Dopo aver montato tutte le pareti bisogna coprire il tetto con la guaina in dotazione.

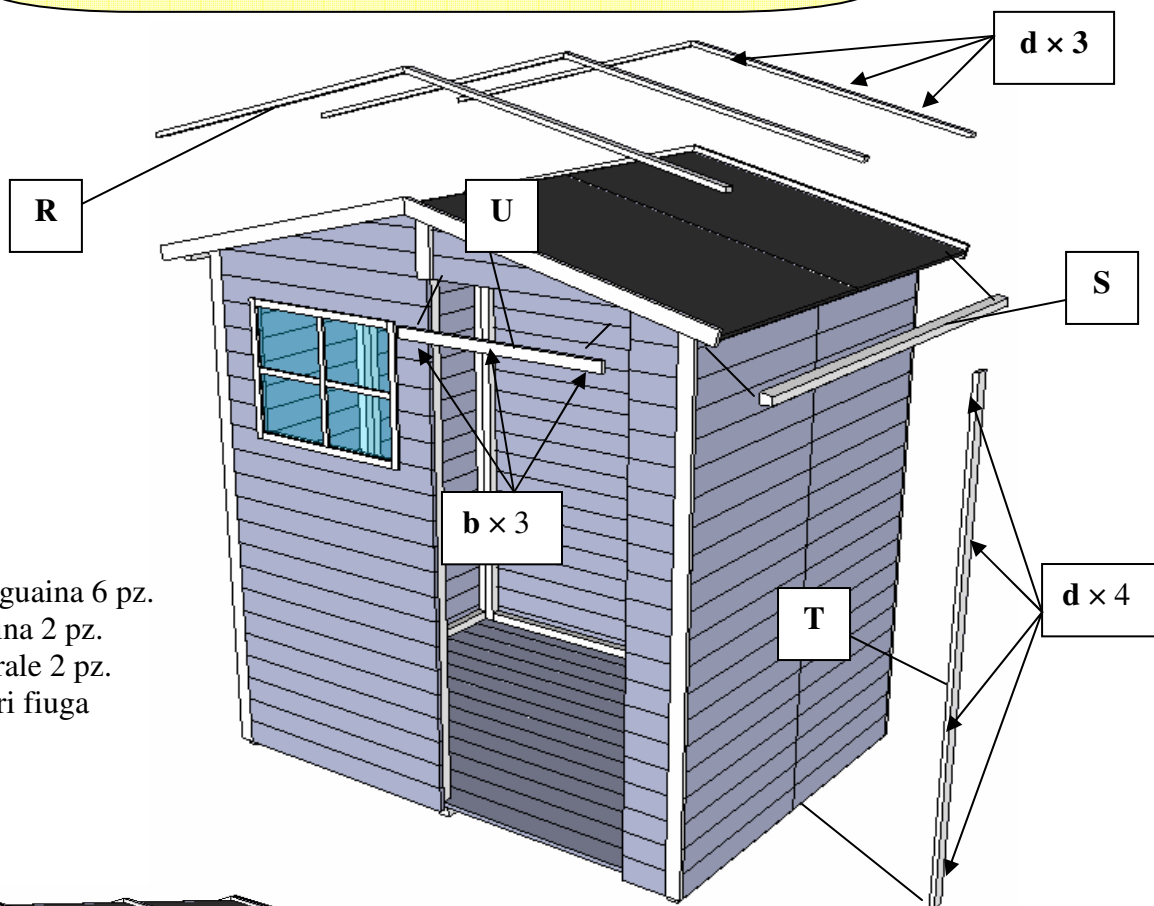

- R** – Listello per guaina 6 pz.
- S** – Listello perlina 2 pz.
- T** – Listello laterale 2 pz.
- U** – Listello copri fuga

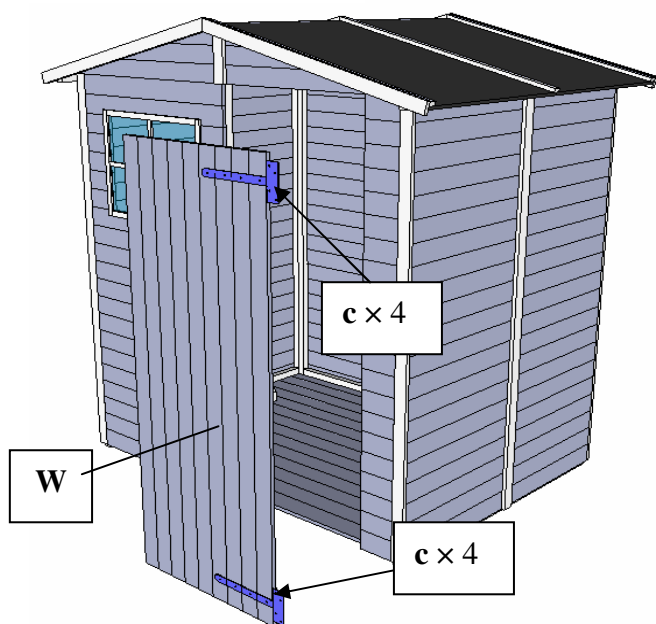

W- Porta

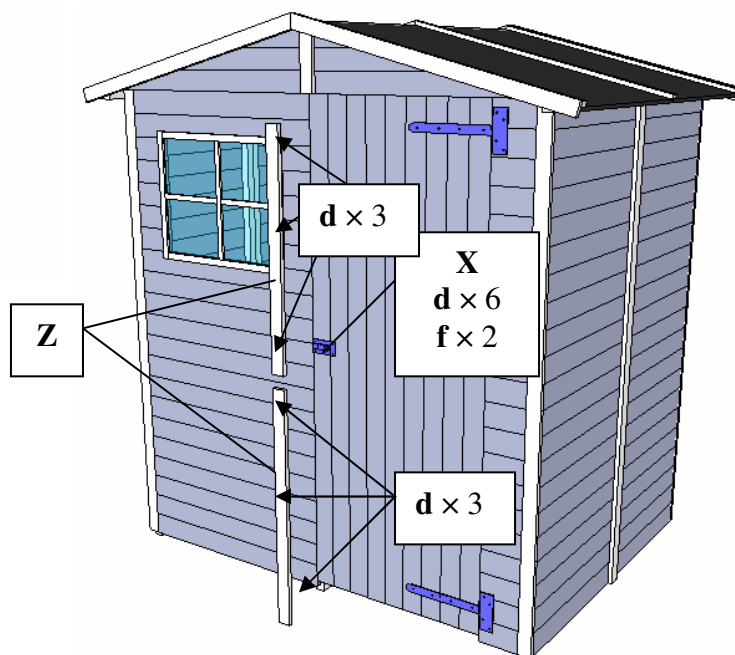

- X** – Chiavistello
- Z** – Listello ferma porta 2 pz.